

WDC RAIL SYSTEM

TT.01

MODIFIED BY: NW, FX

CHECKED BY:

DRAWN BY: BK, DC, ES

SCALE: VARIES

DATE: 08-05-2007

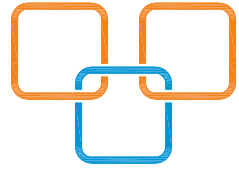

SOLAR DECATHLON COMPETITION 2007
UNIVERSITY OF ILLINOIS
U.S. DEPARTMENT OF ENERGY

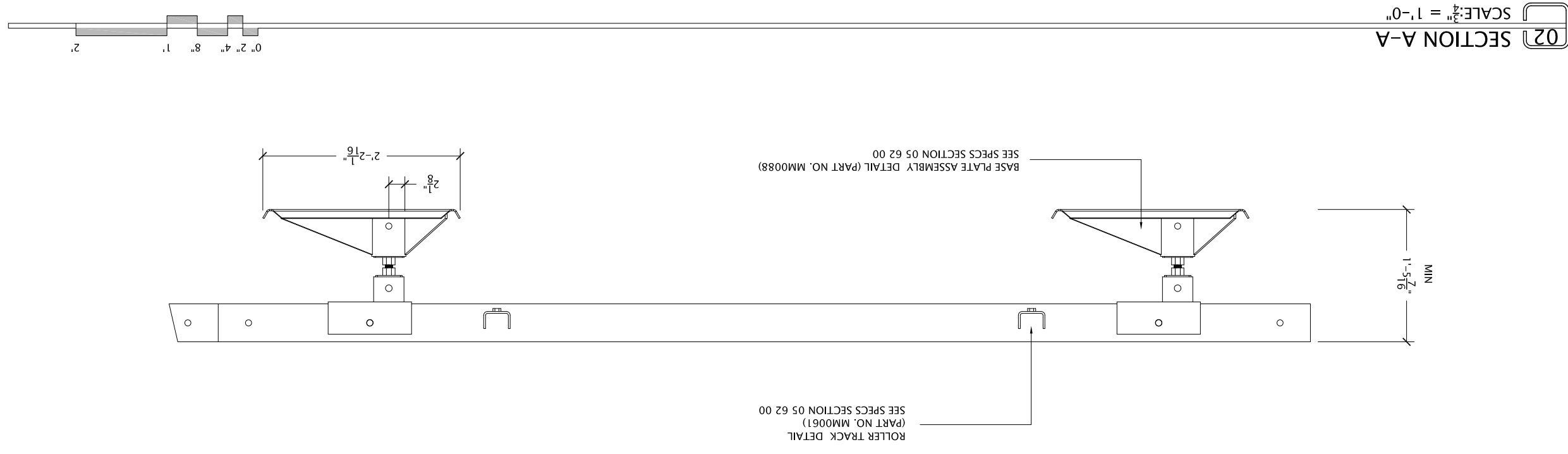
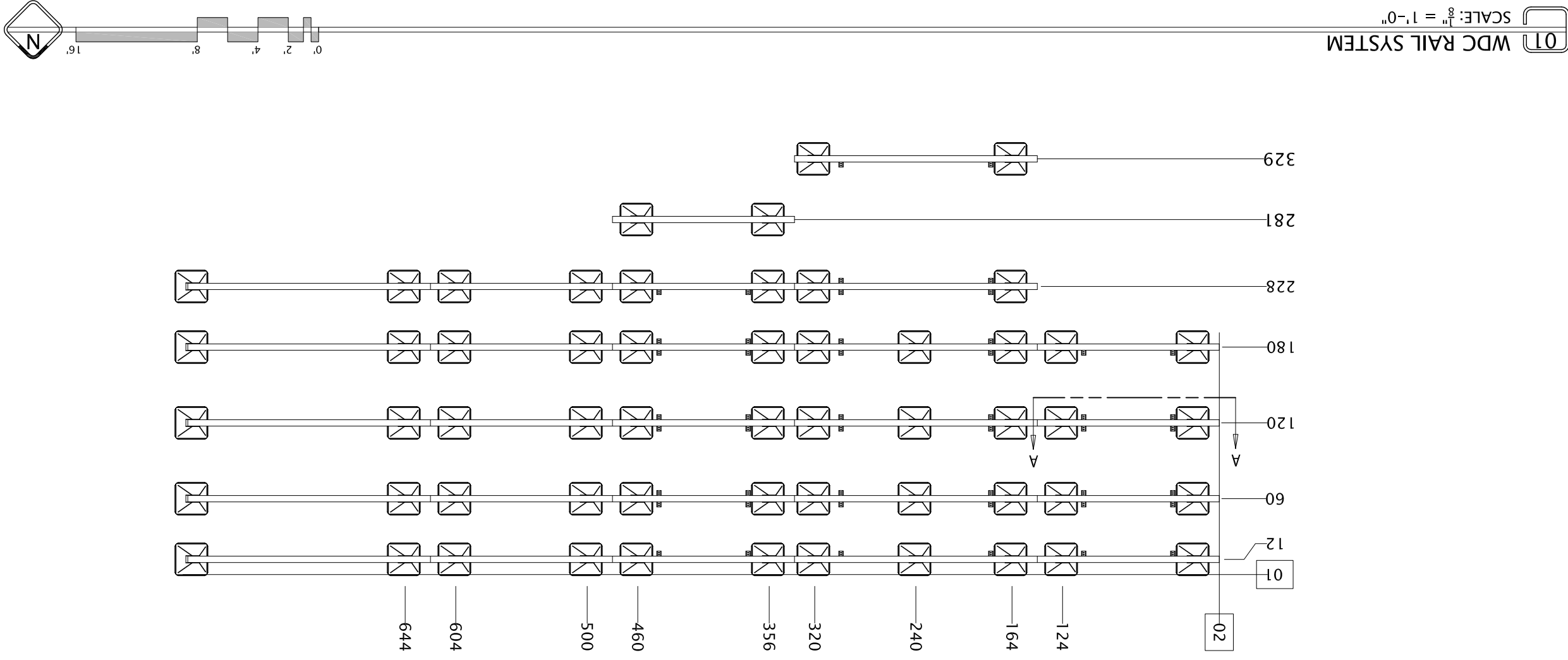

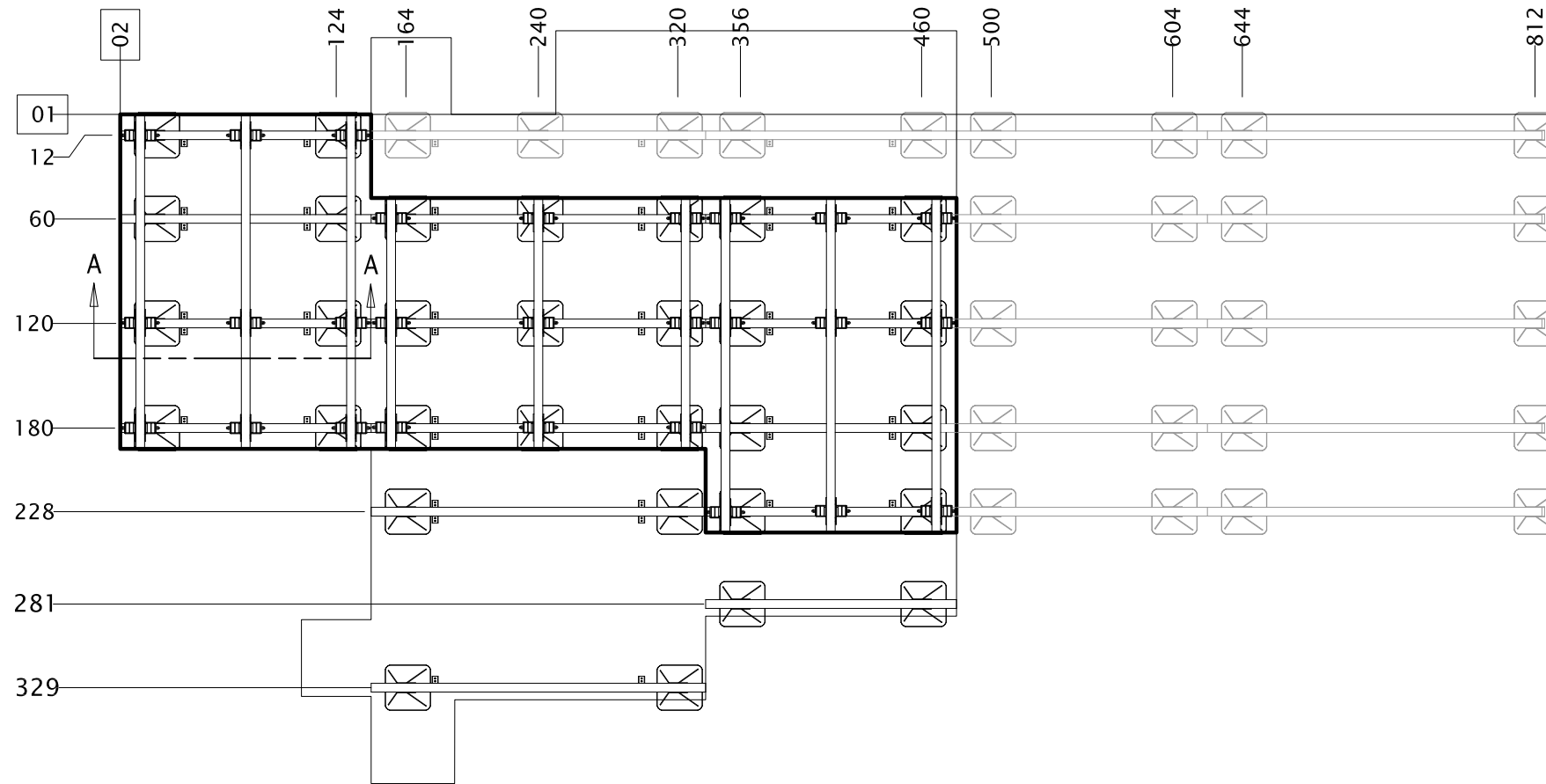

01 WDC RAIL SYSTEM
SCALE: $\frac{1}{8}" = 1'-0"$

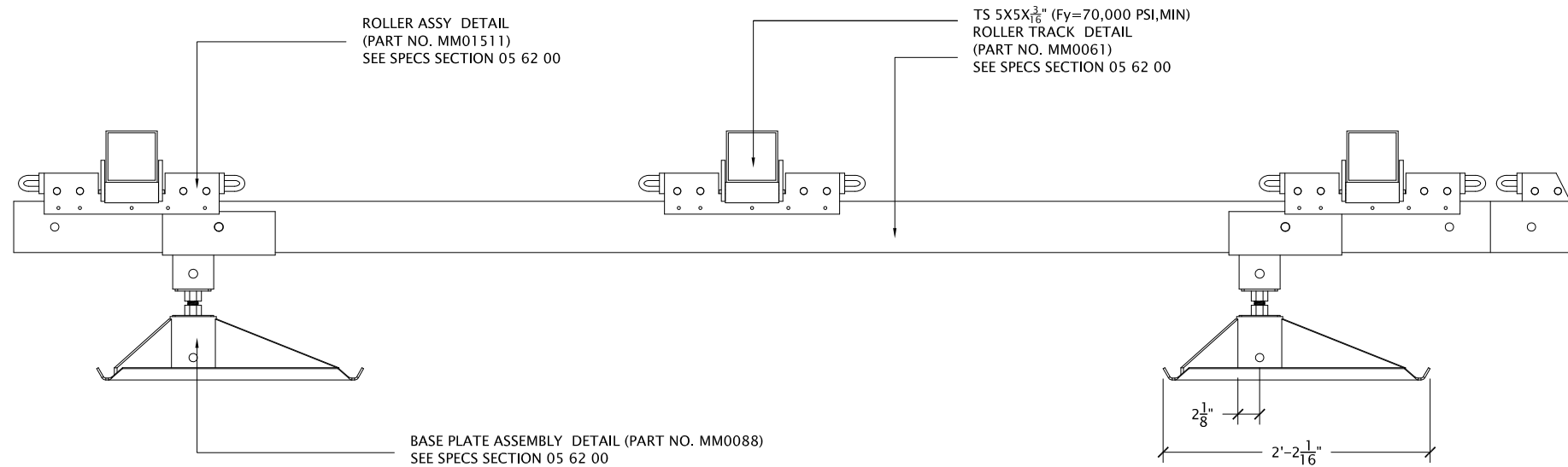
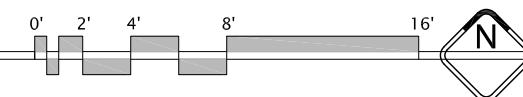

02 SECTION A-A
SCALE: $\frac{3}{4}" = 1'-0"$

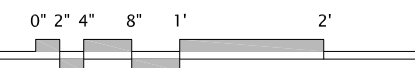

SOLAR DECATHLON COMPETITION 2007
UNIVERSITY OF ILLINOIS
 U.S. DEPARTMENT OF ENERGY



DATE:	08-05-2007
SCALE:	VARIES
DRAWN BY:	BK, DC, ES
CHECKED BY:	
MODIFIED BY:	NW, FX

T1.02

RAIL LAYOUT

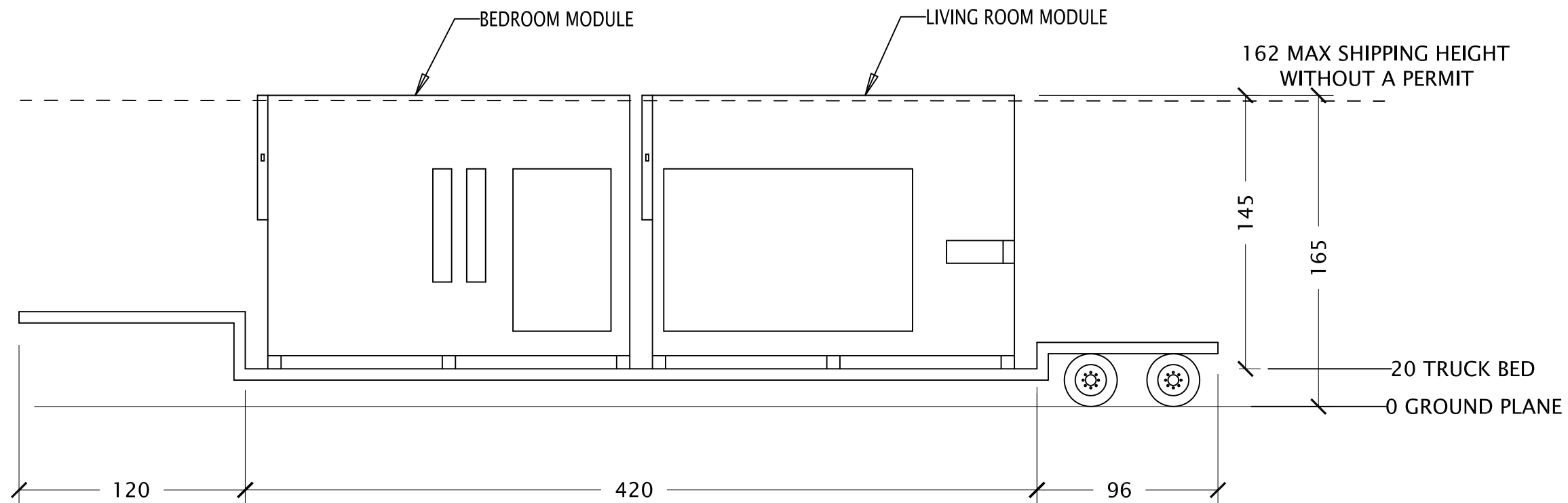
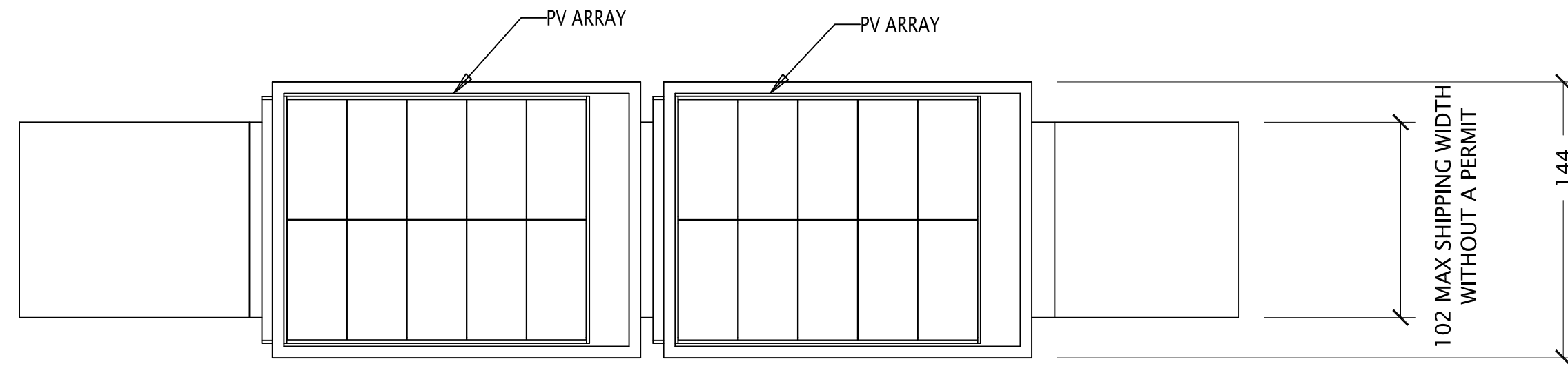

01 SHIPPING TRUCK 1
SCALE: NTS

SOLAR DECATHLON COMPETITION 2007
UNIVERSITY OF ILLINOIS
U.S. DEPARTMENT OF ENERGY

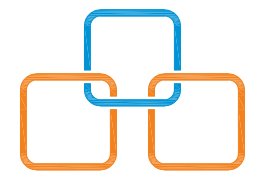

DATE:	08-05-2007
SCALE:	NTS
DRAWN BY:	BK, DC, ES
CHECKED BY:	
MODIFIED BY:	NW, FX

T2.01
TRUCK 1

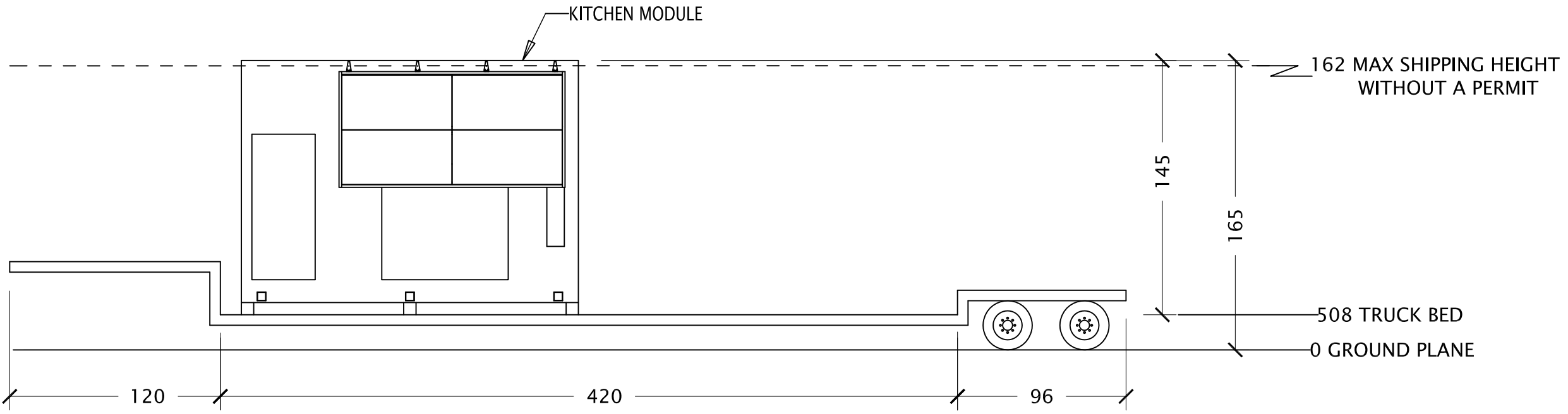
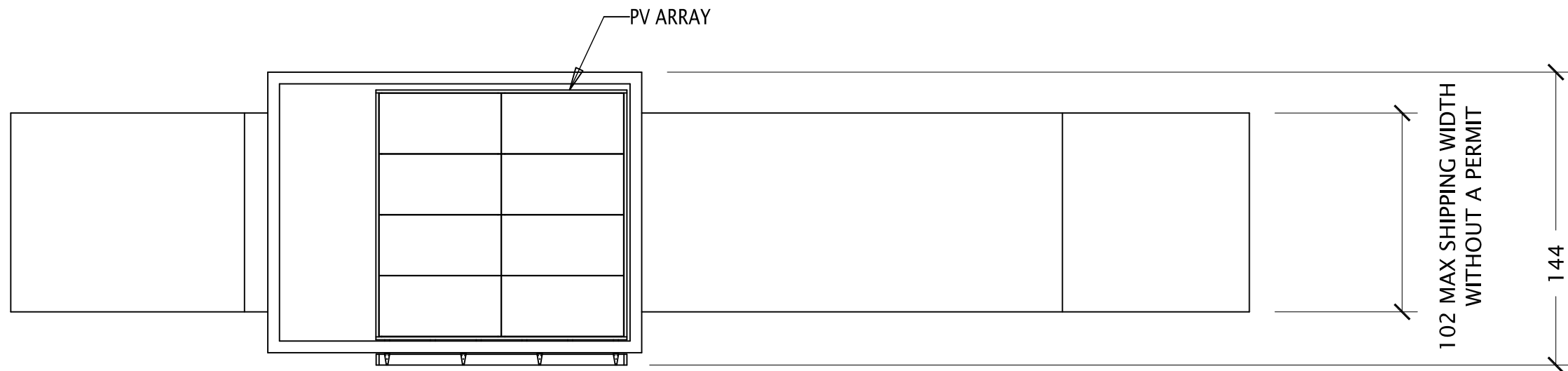

01 SHIPPING TRUCK 2
SCALE: NTS

SOLAR DECATHLON COMPETITION 2007
UNIVERSITY OF ILLINOIS
U.S. DEPARTMENT OF ENERGY

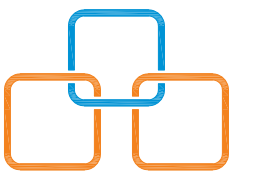

DATE:	08-05-2007
SCALE:	NTS
DRAWN BY:	BK, DC, ES
CHECKED BY:	
MODIFIED BY:	NW, FX

T2.02

TRUCK 2

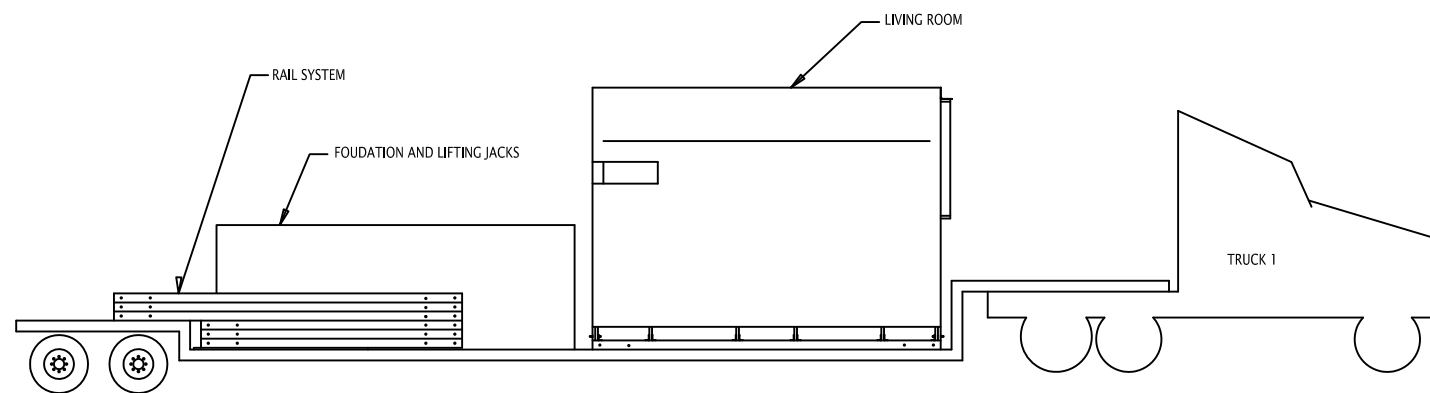
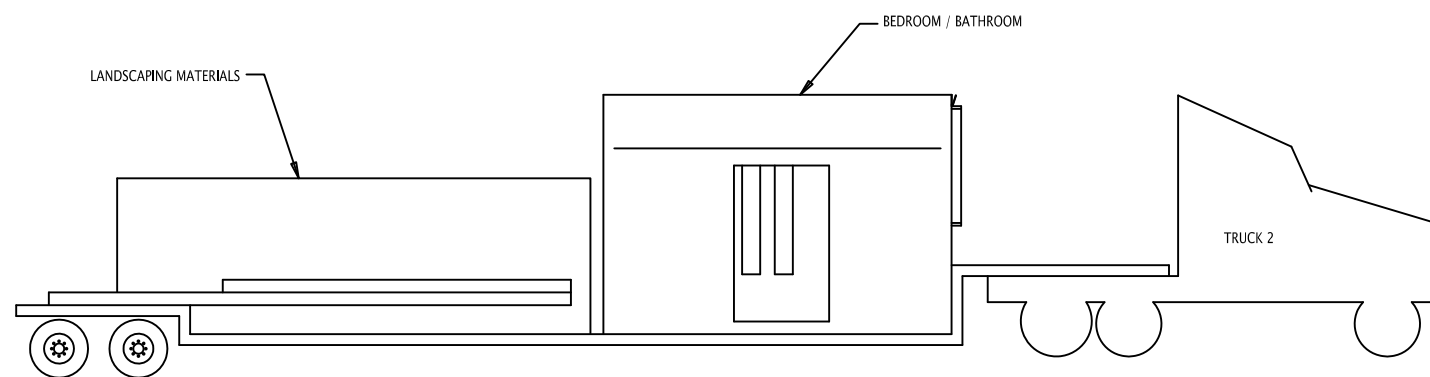
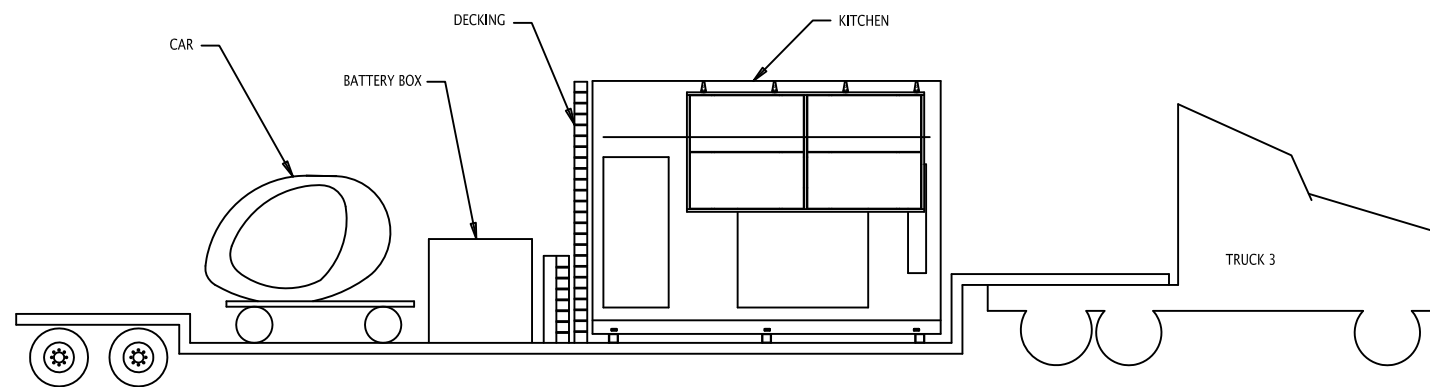

01 TRUCK LAYOUT
SCALE: N.T.S.

SOLAR DECATHLON COMPETITION 2007
UNIVERSITY OF ILLINOIS
U.S. DEPARTMENT OF ENERGY

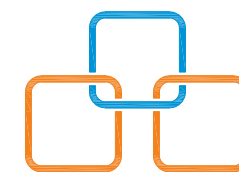

DATE: 08-05-2007

SCALE: NTS

DRAWN BY: BK, DC, ES

CHECKED BY: NW

MODIFIED BY: NW, FX

T2.03

TRUCK LAYOUT

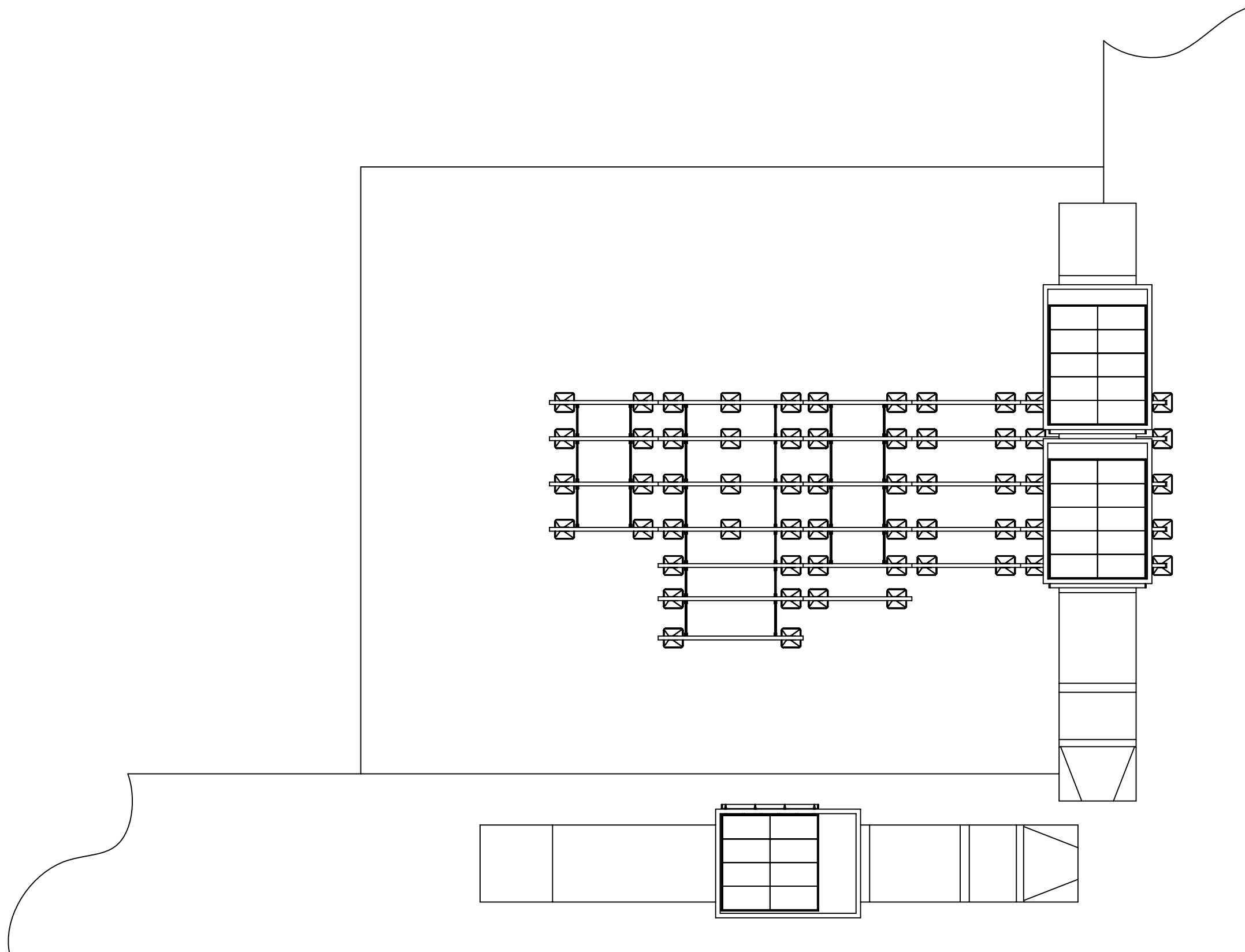

01 SITE OPERATIONS
SCALE: NTS

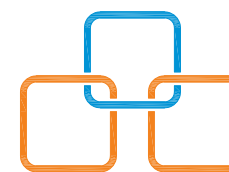

SOLAR DECATHLON COMPETITION 2007
UNIVERSITY OF ILLINOIS
U.S. DEPARTMENT OF ENERGY

DATE: 08-05-2007

SCALE: NTS

DRAWN BY: BK, DC, ES

CHECKED BY:

MODIFIED BY: NW, FX

T2.04

SITE OPS

0.0 Hour

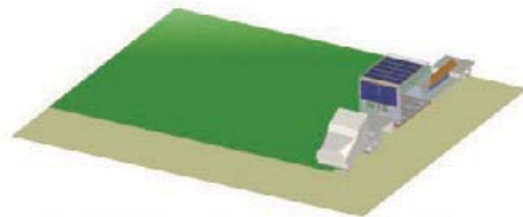

Truck 1 contents: living room module, foundation rail system

2.0 Hour

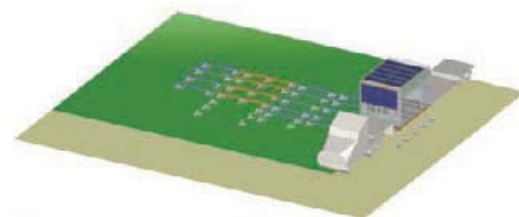

Deploy rail system

2.1 Hour

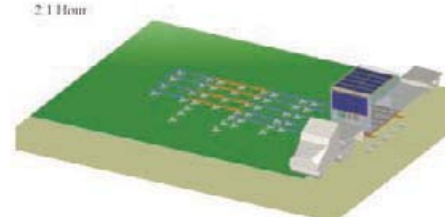

2.3 Hour

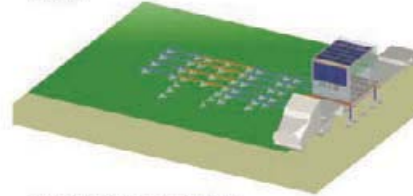

Lift module above rear deck of truck

2.4 Hour

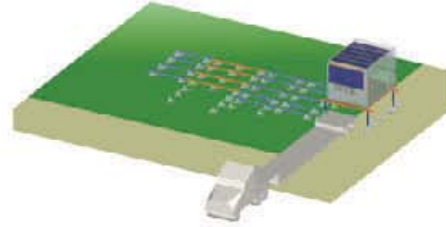

2.5 Hour

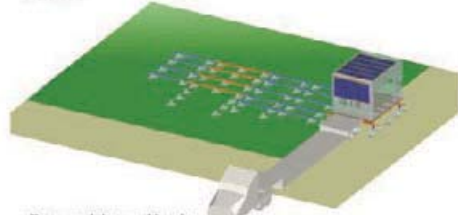

Bring module to rail height

2.6 Hour

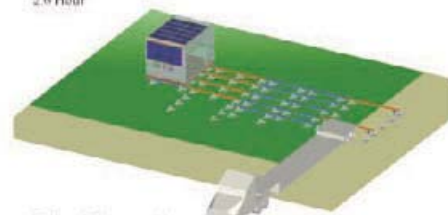

Roll module into position

2.8 Hour

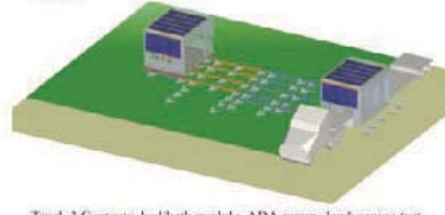

Truck 2 Contents: bed/bath module, ADA ramps, landscaping (set aside for now)

2.9 Hour

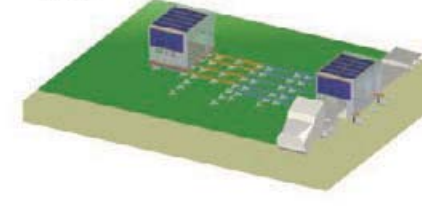

3.1 Hour

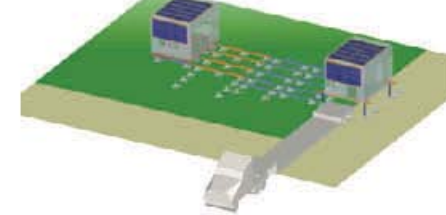

3.2 Hour

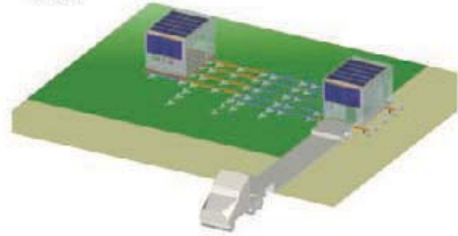

Lower onto E-W rail system

3.3 Hour

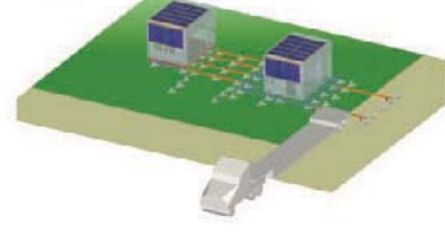

Redeploy rails to support deck

3.5 Hour



Truck 3 contents: kitchen module, decks, car (set aside), battery box

4.2 Hour



Redeploy rail system to bring kitchen in from south

4.3 Hour



4.4 Hour

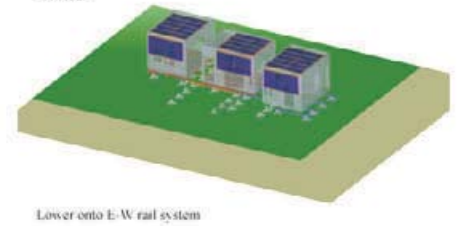

Lower onto E-W rail system

5.0 Hour

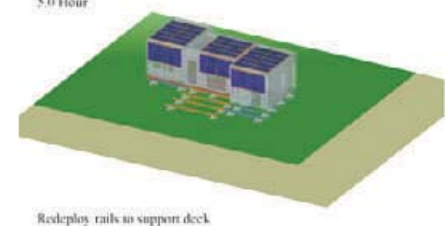

Redeploy rails to support deck

6.0 Hour

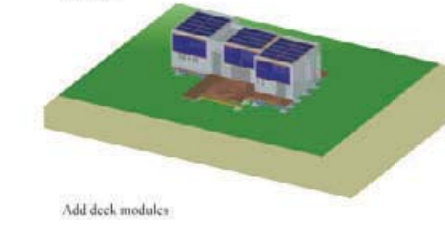

Add deck module

6.1 Hour

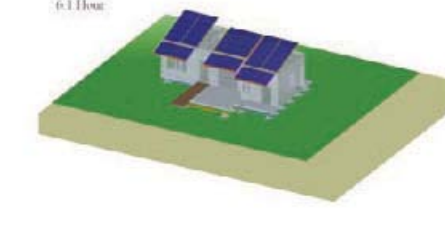

6.5 Hour

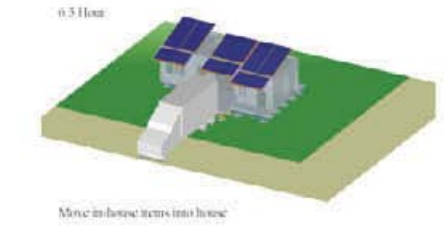

Move in-house items into house

SOLAR DECATHLON COMPETITION 2007
UNIVERSITY OF ILLINOIS
U.S. DEPARTMENT OF ENERGY



DATE: 08-05-2007

SCALE: NTS

DRAWN BY: BK, DC, ES

CHECKED BY:

MODIFIED BY: NW, FX

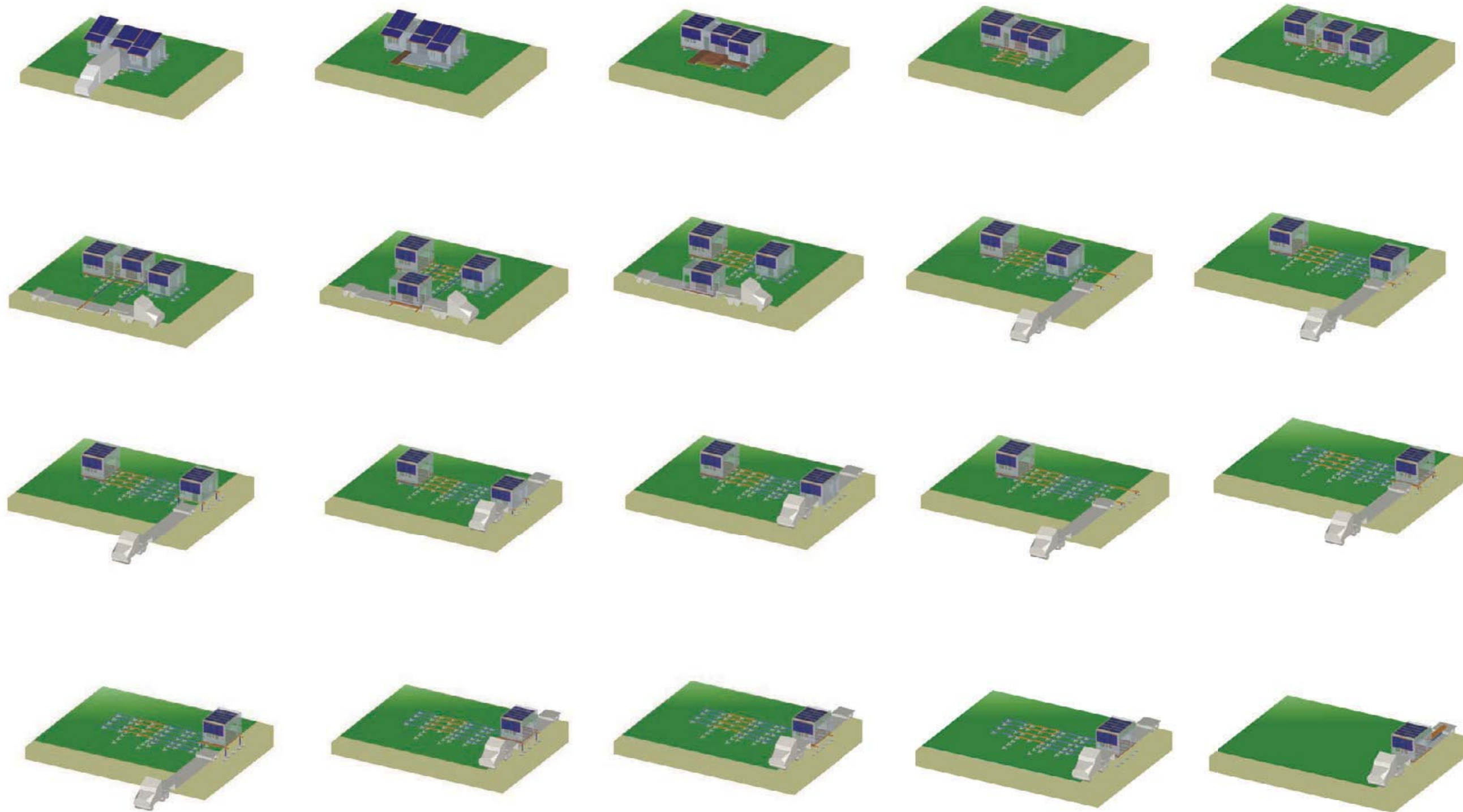

DATE:	08-05-2007
SCALE:	NTS
DRAWN BY:	BK, DC, ES
CHECKED BY:	
MODIFIED BY:	NW, FX

T2.06

DISASSEMBLY

NOTE: DISASSEMBLY IS A REVERSE PROCESS OF ASSEMBLY